

IALL 10.5 Lab Notes

Partlist

Capacitores

3	C1, C2, C3	100uF x 450V
1	C4	100uF x 50V
1	C5	10uF x 50V
3	C6, C7, C8	100nF x 350V
1	C9	100pF

Semicondutores

2	D1, D2	1N4007
---	--------	--------

Resistências

1	R1	2.2k x 1W
1	R2, R12	220k x 1W
2	R7, R8	470k x 1W
3	R9, R13, R15	1M
1	R10	1.5k x 2W
1	R11	220k x 2W
1	R3	1.5k x 2W
1	R4	220 ohms x 2W
2	R5, R6	10k x 2W
1	R14	330 ohms x 5W

Válvulas

2	V1, V2	ECL82
---	--------	-------

Tranformador

Força

Primário: 0+127+220V

Secundário: 190+190V @ 120mA, 3.15+3.15V @ 2A

Audio

Primário: PP: 10.000 Ohms, com derivação central

Secundário: 0+4+8 Ohms

Potência: 11 watts

Fotos

Protótipo Big Louis

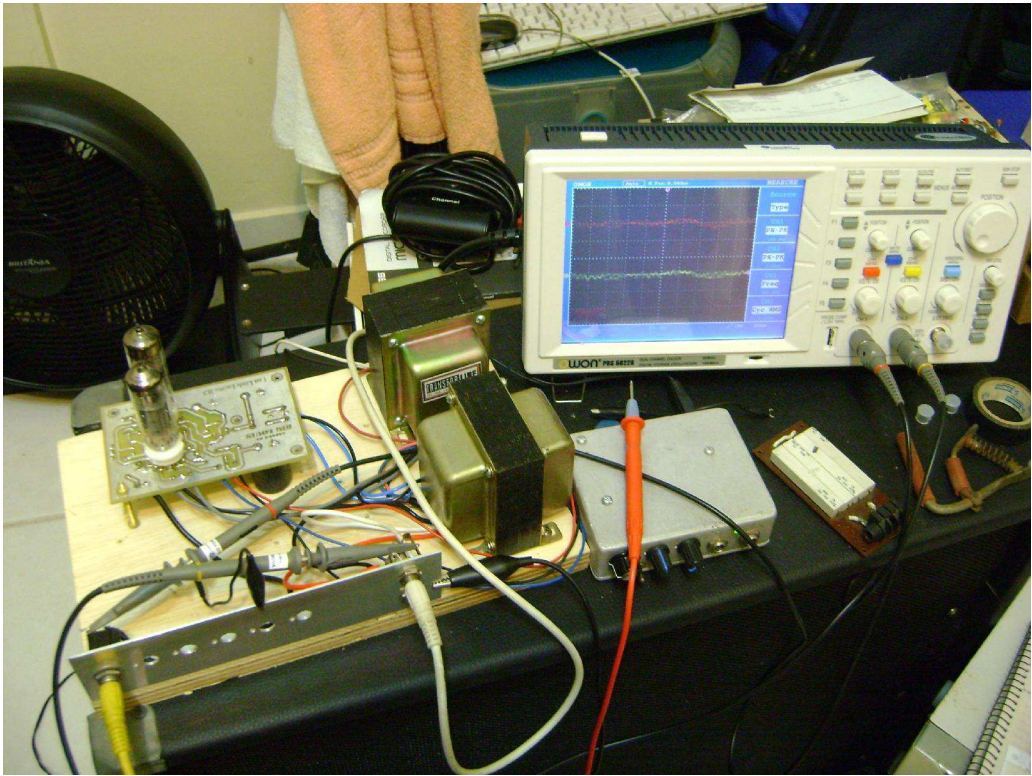
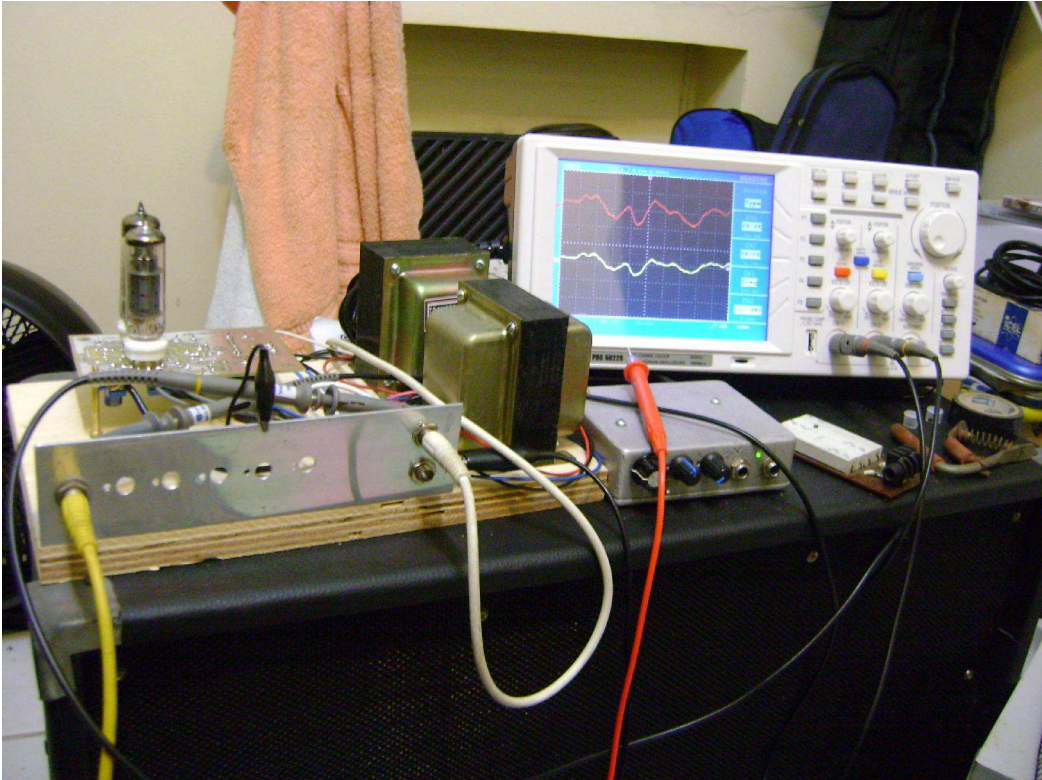

Protótipo Jorge R



TRIODE-OUTPUT PENTODE

The triode section is intended for use as frame oscillator and A.F. amplifier. The pentode section is intended for use as frame output tube and A.F. power amplifier.

QUICK REFERENCE DATA		
<u>Triode section</u>		
Anode current	I_a	3.5 mA
Transconductance	S	2.2 mA/V
Amplification factor	μ	70 -
<u>Pentode section</u>		
Anode peak voltage	V_{ap}	max. 2.5 kV
Anode current	I_a	41 mA
Transconductance	S	7.5 mA/V
Amplification factor	$\mu_{g_2g_1}$	9.5 -
Output power	W_o	3.5 W

HEATING: Indirect by A.C. or D.C.; parallel supply

Heater voltage

V_f 6.3 V

Heater current

I_f 780 mA

DIMENSIONS AND CONNECTIONS

Dimensions in mm

Base: Noval

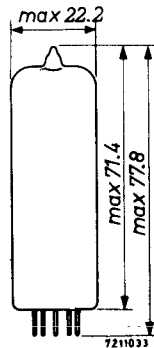
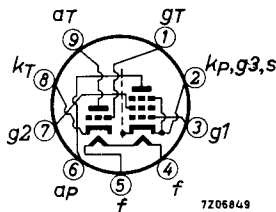

CAPACITANCES

Triode section

Anode to all except grid	$C_{a(g)}$	4.3	pF
Grid to all except anode	$C_{g(a)}$	2.7	pF
Anode to grid	C_{ag}	4.4	pF
Grid to heater	C_{gf}	max. 0.1	pF

Pentode section

Anode to all except grid No.1	$C_{a(g_1)}$	8.0	pF
Grid No.1 to all except anode	$C_{g_1(a)}$	9.3	pF
Anode to grid No.1	C_{ag_1}	max. 0.3	pF
Grid No.1 to heater	C_{g_1f}	max. 0.3	pF

Between triode and pentode sections

Anode triode to grid No.1 pentode	C_{aTg_1P}	max. 0.02	pF
Grid triode to anode pentode	C_{gTaP}	max. 0.02	pF
Grid triode to grid No.1 pentode	C_{gTg_1P}	max. 0.025	pF
Anode triode to anode pentode	C_{aTaP}	max. 0.25	pF

TYPICAL CHARACTERISTICS

Triode section

Anode voltage	V_a	100	V
Grid voltage	V_g	0	V
Anode current	I_a	3.5	mA
Transconductance	S	2.2	mA/V
Amplification factor	μ	70	-

Pentode section

Anode voltage	V_a	170	V
Grid No.2 voltage	V_{g_2}	170	V
Grid No.1 voltage	V_{g_1}	-11.5	V
Anode current	I_a	41	mA
Grid No.2 current	I_{g_2}	9	mA
Transconductance	S	7.5	mA/V
Amplification factor	$\mu_{g_2g_1}$	9.5	-
Internal resistance	R_i	16	k Ω

OPERATING CHARACTERISTICS

Triode section as A.F. amplifier

A. Signal source resistance	R_s	0.22			$M\Omega$
Grid resistor	R_g	3			$M\Omega$
Grid resistor of next stage	R_g	0.68			$M\Omega$
Supply voltage	V_b	200	170	V	
Cathode resistor	R_k	2.2	2.7	$k\Omega$	
Anode resistor	R_a	220	220	$k\Omega$	
Anode current	I_a	0.52	0.43	mA	
Voltage gain	V_o/V_i ¹⁾	52	51	-	
Max. output voltage	V_o max	26	25	V_{RMS}	
Distortion	d_{tot} ²⁾	1.6	2.3	%	

B. Signal source resistance	R_s	0.22				$M\Omega$
Grid resistor	R_g	22				$M\Omega$
Grid resistor of next stage	R_g'	0.68				$M\Omega$
Supply voltage	V_b	200	200	170	170	V
Cathode resistor	R_k	0	0	0	0	Ω
Anode resistor	R_a	100	220	100	220	$k\Omega$
Anode current	I_a	1.05	0.61	0.86	0.50	$M\Omega$
Voltage gain	V_o/V_i ¹⁾	50	55	49	53	-
Max. output voltage	V_o max	24	25	19	20	V_{RMS}
Distortion	d_{tot} ³⁾	1.5	1.4	1.4	1.4	%

MICROPHONY AND HUM

The triode section can be used without special precautions against microphony and hum in circuits in which an input voltage of minimum 10 mV_{RMS} is required for an output of 50 mW of the output stage. $Z_g(50 \text{ Hz}) = 0.25 M\Omega$.

1) Measured at small input voltage.

2) At lower output voltages the distortion is proportionally lower.

3) At lower output voltages down to 5 V_{RMS} the distortion is approximately constant. At values below 5 V_{RMS} the distortion is approximately proportional to V_o .

OPERATING CHARACTERISTICS

Pentode sectionA.F. power amplifier, class A (measured with V_k constant)

Supply voltage	$V_{ba} = V_{bg_2}$	200	272	V
Grid No.2 series resistor (non-decoupled)	R_{g_2}	470	2200	Ω
Cathode resistor	R_k	330	650	Ω
Load resistance	$R_{a\sim}$	4.5	8	k Ω
Grid No.1 driving voltage	V_i	0 0.66 6.7	0 0.9 9.5	V_{RMS}
Anode current	I_a	35 37	28 27	mA
Grid No.2 current	I_{g_2}	7.8 13.3	6.5 10.8	mA
Output power	W_o	0 0.05 3.3	0 0.05 3.5	W
Distortion	d_{tot}	- - 10	- - 10	%

A.F. power amplifier, class AB, two tubes in push-pull

Anode supply voltage	V_{ba}	200	250	V
Grid No.2 supply voltage	V_{bg_2}	200	200	V
Common cathode resistor	R_k	170	220	Ω
Load resistance	$R_{aa'\sim}$	4.5	10	k Ω
Grid No.1 driving voltage	V_i	0 14.2	0 12.5	V_{RMS}
Anode current	I_a	2x35 2x42.5	2x28 2x31	mA
Grid No.2 current	I_{g_2}	2x8 2x16.5	2x5.8 2x13	mA
Output power	W_o	0 9.3	0 10.5	W
Distortion	d_{tot}	- 6.3	- 4.8	%

Frame output application

The circuit should operate satisfactorily with a peak anode current $I_{ap} = 85$ mA at $V_a = 50$ V, $V_{g_2} = 170$ V, $V_f = 6.3$ V. The minimum available I_{ap} at end of life is;

70 mA at $V_a = 50$ V, $V_{g_2} = 170$ V, $V_f = 5.5$ V

80 mA at $V_a = 50$ V, $V_{g_2} = 190$ V, $V_f = 5.5$ V.

LIMITING VALUES (Design centre rating system)

Triode section

Anode voltage	V_{a0}	max. 550 V
	V_a	max. 300 V
Anode peak voltage	V_{ap}	max. 600 V ¹⁾
Anode dissipation	W_a	max. 1 W
Cathode current, average	I_k	max. 15 mA
peak	I_{kp}	max. 100 mA ¹⁾
Grid resistor for fixed bias	R_g	max. 1 M Ω
for automatic bias	R_g	max. 3 M Ω
Grid impedance at 50 Hz	Z_g	max. 0.5 M Ω
Cathode to heater voltage	V_{kf}	max. 100 V

Pentode section

Anode voltage	V_{a0}	max. 550 V
	V_a	max. 300 V
Anode peak voltage, positive	V_{ap}	max. 2.5 kV ¹⁾
negative	$-V_{ap}$	max. 500 V
Anode dissipation for frame output application	W_a	max. 5 W
for A.F. output application	W_a	max. 7 W
Grid No.2 voltage	V_{g20}	max. 550 V
	V_{g2}	max. 300 V
Grid No.2 dissipation, average	W_{g2}	max. 2 W
peak	W_{g2p}	max. 3.2 W
Cathode current	I_k	max. 50 mA
Grid No.1 resistor for fixed bias	R_{g1}	max. 1 M Ω
for automatic bias	R_{g1}	max. 2 M Ω
Cathode to heater voltage	V_{kf}	max. 150 V

For curves of the ECL82 please refer to PCL82

¹⁾ Max. pulse duration 4% of a cycle with a maximum of 0.8 msec.

PHILIPS

Data handbook



Electronic
components
and materials

ECL82

page	sheet	date
1	1	1969.12
2	2	1969.12
3	3	1969.01
4	4	1969.12
5	5	1969.01
6	FP	1999.08.15

IALL 10.5: Two ECL-82 tube guitar amplifier

Author: Haroldo Gamal

version: 1.0

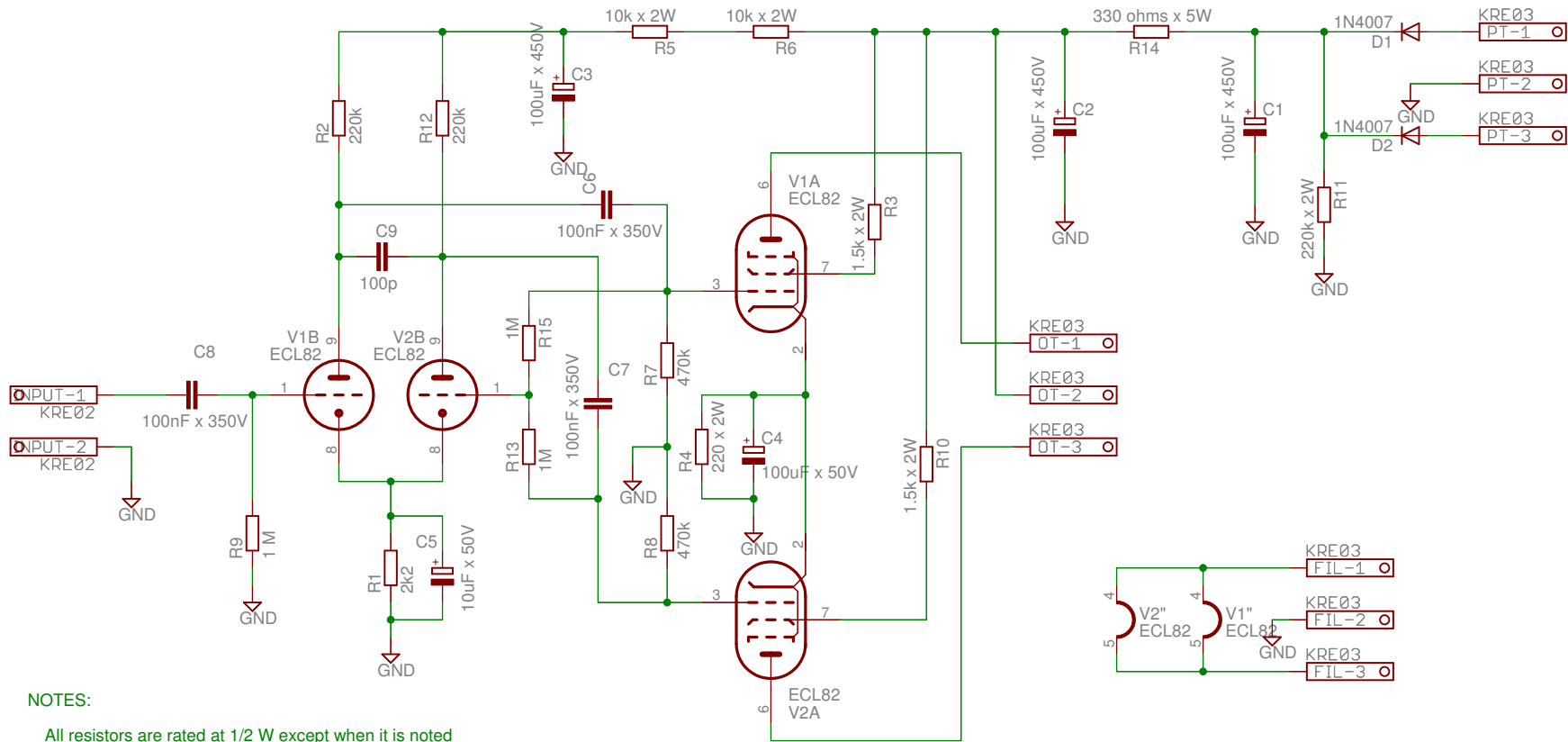

NOTES:

All resistors are rated at 1/2 W except when it is noted

OT: PP 10000 ohms x 4/8 ohms - grain oriented steel transformer

PT: Primary: 127V; Secondary: 190V + 190V @ 100 mA, 3.15V + 3.15 V @ 3A

Use shielded cable to connect input (INPUT)

Haroldo Gamal (C) 2009

iall-10.5-1.0-3

5/16/10 4:54 PM

Sheet: 1/1

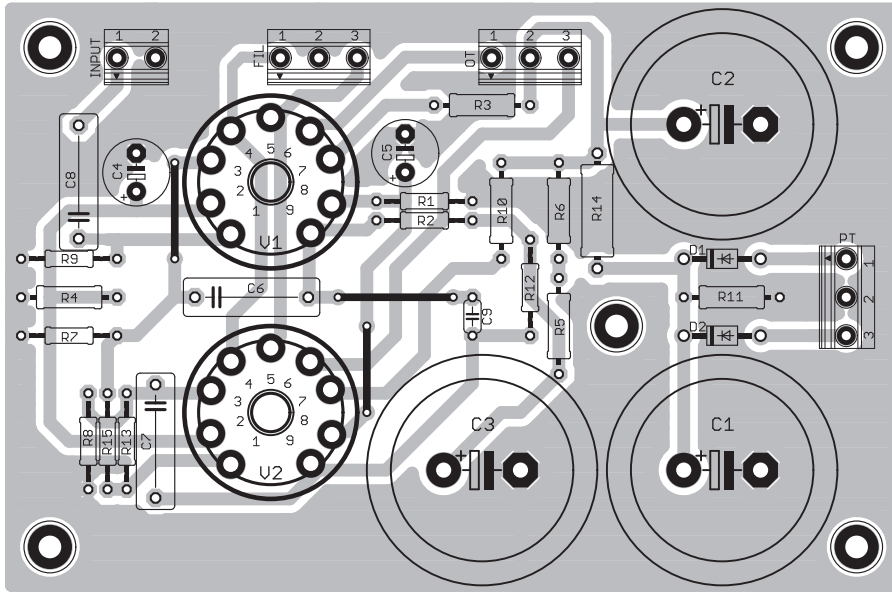

116,841 mm

76,2 mm

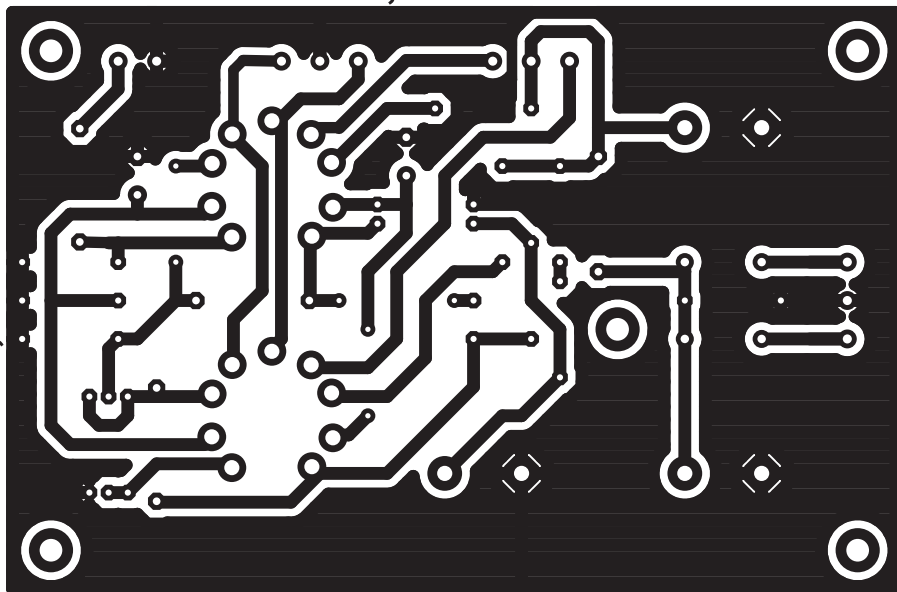

6,43 cm

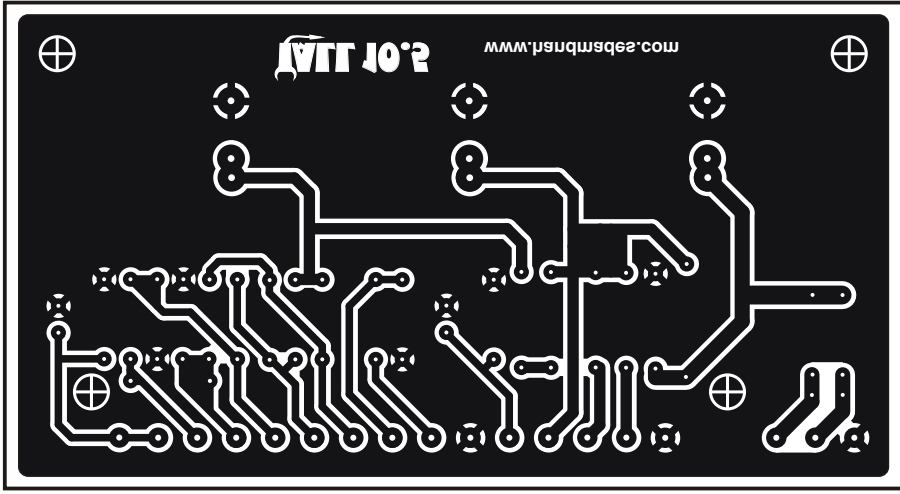

11,87 cm

